

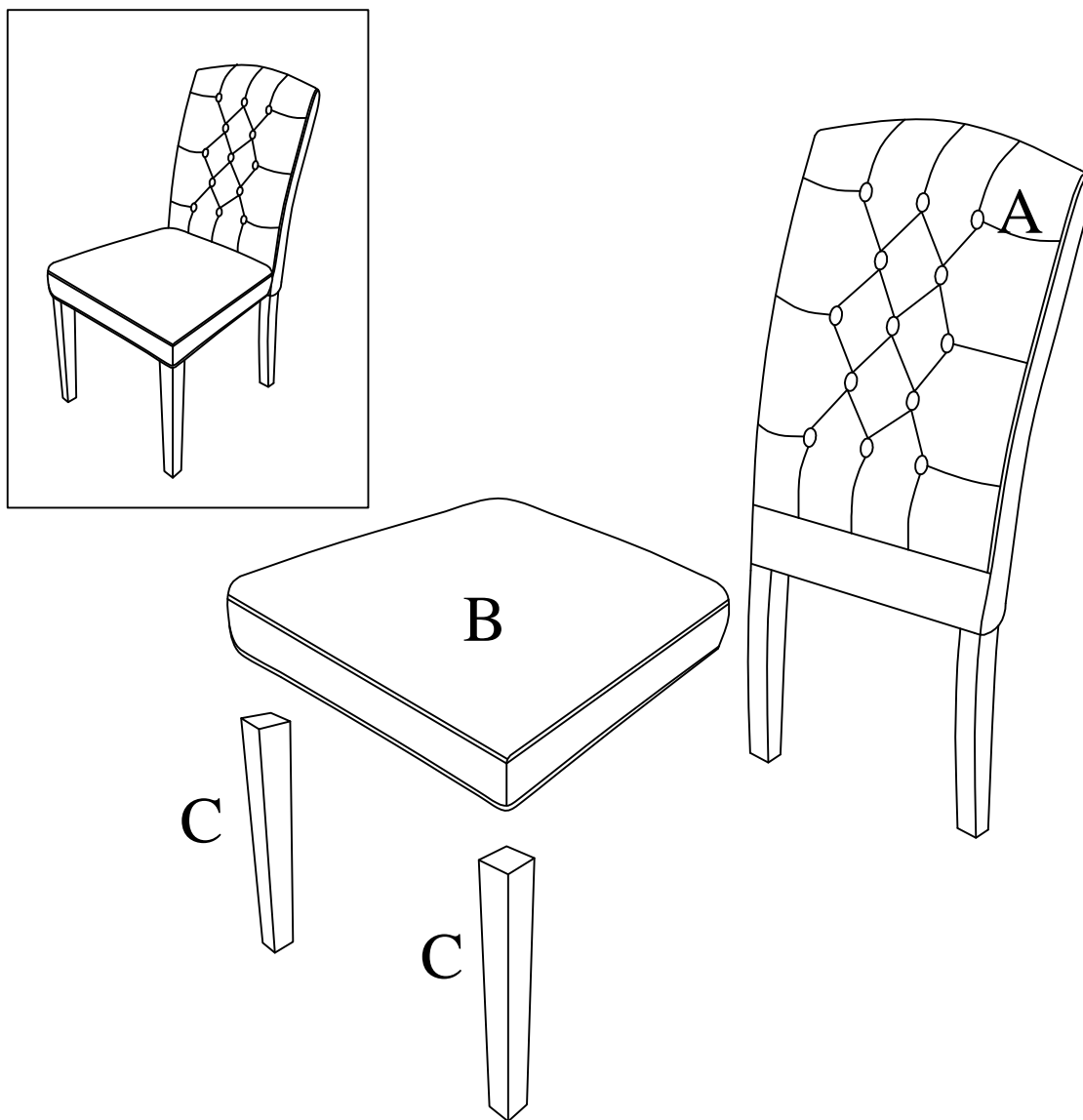





202-157 LUCIAN
 ASSEMBLY INSTRUCTIONS
 INSTRUCTION D'ASSEMBLAGE

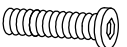

TURN TOP UPSIDE DOWN ON A SOFT WORKING SURFACE.

RETOURNEZ LE MEUBLE DANS L' AUTRE SENS SUR UNE SURFACE DE TRAVAIL NON RIGIDE.

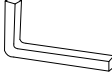
a  11 pcs / unités	b  11 pcs / unités	c  3-1/2" 4 pcs / unités
d  2-1/2" 4 pcs / unités	e  2" 3 pcs / unités	f  1 pc / unités

202-157 LUCIAN
ASSEMBLY INSTRUCTIONS
INSTRUCTION D'ASSEMBLAGE

STEP 1 / ÉTAPE 1

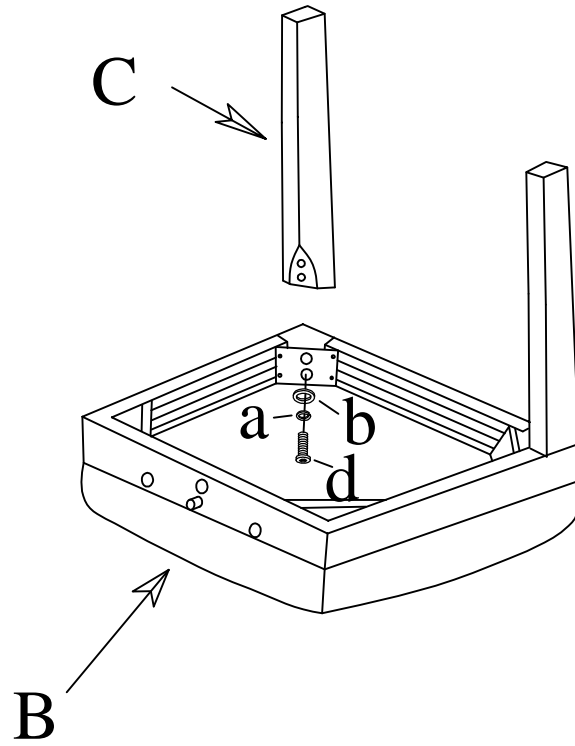

STEP 2 / ÉTAPE 2

