



## **ASSEMBLY INSTRUCTIONS**

Congratulations on your purchase – Get ready to be inspired!

Please check to ensure that all parts are included. Contact place of purchase for any service issues. Keep this document for reference in case parts are needed.

## ***INSTRUCTION D'ASSEMBLAGE***

*Félicitons d'avoir acheté - Apprêtez-vous à être inspirés!*





*Veillez vous assurer d'avoir toutes les pièces. Nous vous conseillons de contacter l'endroit où vous avez fait votre achat si vous nécessitez un service quelconque. Veuillez conserver ce document à titre de référence si vous avez besoin de pièces.*

# MODUS 401-197

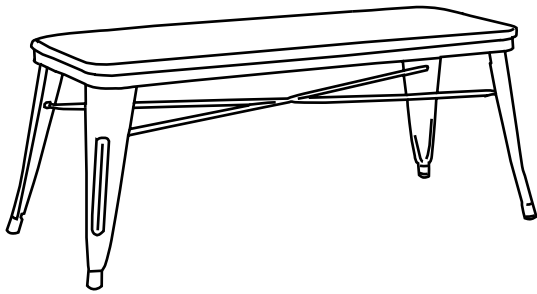
## ASSEMBLY INSTRUCTION

## INSTRUCTION D'ASSEMBLAGE



PART LIST	QUANTITY
LISTE DES PIECES	QUANTITE
	1
	16
	4
	1
	1

STEP 1 / ETAPE 1

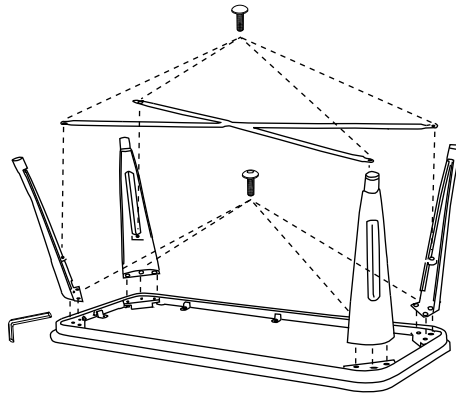

STEP 2 / ETAPE 2

