





# 501- 329 GY Assembly Instruction/ Instructions D' assemblage

## Hardware List / Liste de Materiel

 H1 x 6	 H2 x 6	 H3 x 3	 H4 x 1
---	--	--	--

## Parts List / Liste des Pieces

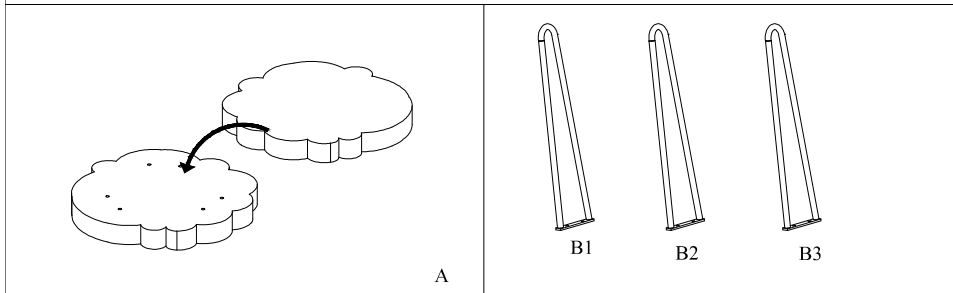

### Step.1 / Etape .1

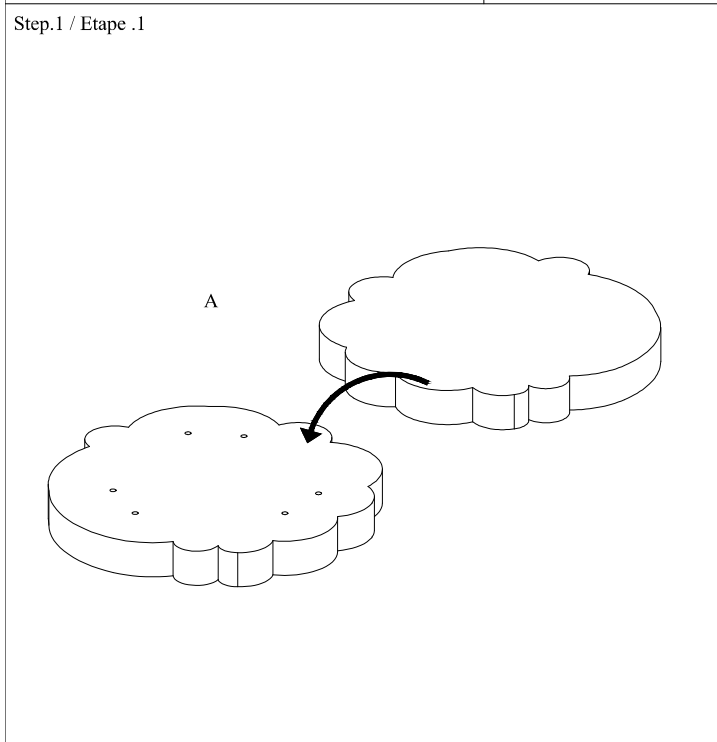

### Step.2 / Etape .2

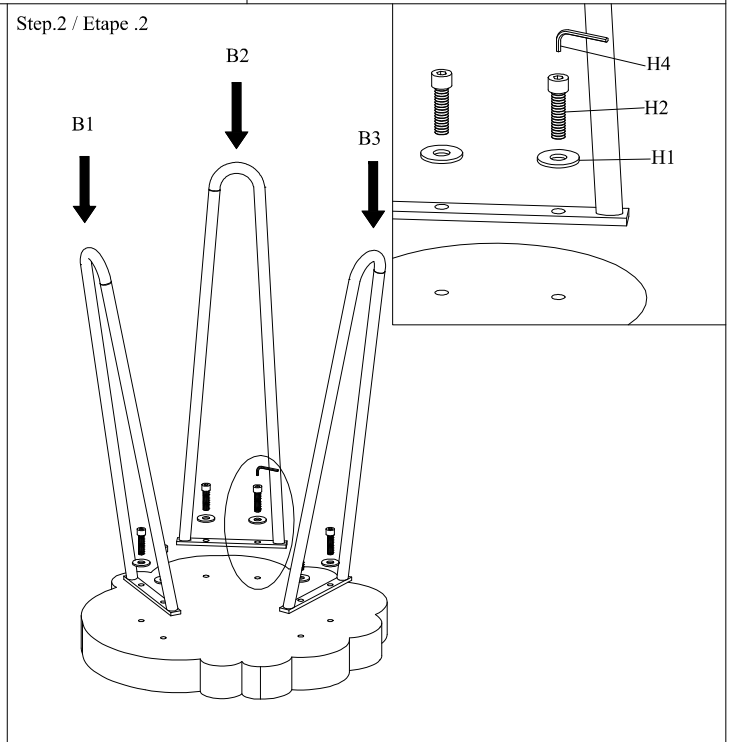

### Step.3 / Etape .3

