

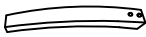







202-080BK/GY/IV & 202-085CM/GY

ASSEMBLY INSTRUCTION/INSTRUCTION D' ASSEMBLAGE

PARTS IDENTIFICATION/
LISTE DE MATERIÉL

No	Drawing	Description	Qty
1		SEAT CUSHION	1
2		BACK LEG	2
3		FORNT LEG	2
B		silver ring	1

HARDWARE LIST/
LISTE DE MATERIÉL

No	Drawing	Description	Qty
A		5mm	1
B		$\phi 5/16 * 2-1/4"$	4
E		$\phi 5/16 * 1-3/4"$	4
C		$\phi 5/16$	8
D		$\phi 5/16$	8

Complete assembly

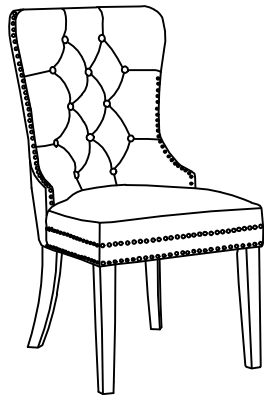

STEP 2

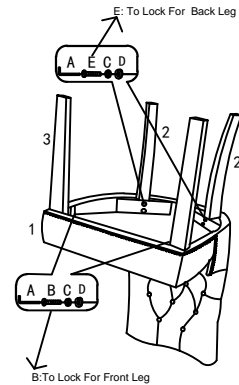

Recover the non-woven cloth

STEP 1

Open the non-woven and take out the Legs(2.3)from seat cushion(1)

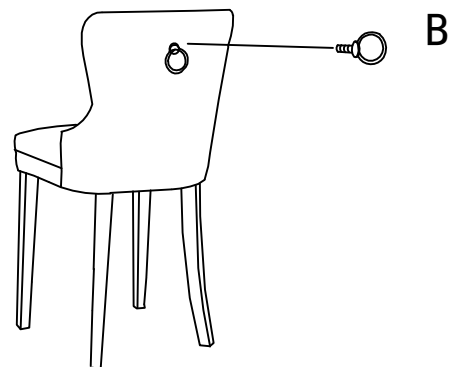
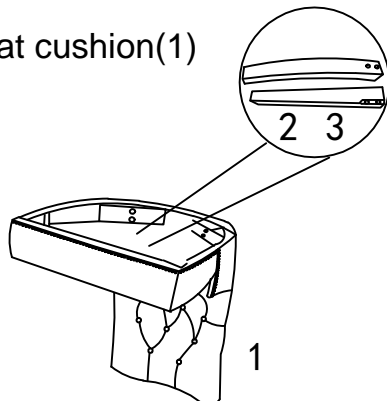

Finally :Take the B (silver ring)put the backrest side