

WORLDWIDE

H O M E F U R N I S H I N G S I N C .

ASSEMBLY INSTRUCTIONS

INSTRUCTION D'ASSEMBLAGE

Thank you for purchasing this product. Please check to ensure that all parts are included. Contact place of purchase for any service issues.

Keep this document for reference in case parts are needed.

Nous vous remercions d'avoir acheté ce produit. Veuillez vous assurer d'avoir toutes les pièces. Nous vous conseillons de contacter l'endroit où vous avez fait votre achat si vous nécessitez un service quelconque. Veuillez conserver ce document à titre de référence si vous avez besoin de pièces.

**** IMPORTANT ****

MUST READ BEFORE ASSEMBLY!

FOR YOUR FURNITURE TO LAST, CORRECT ASSEMBLY AND PROPER MAINTENANCE ARE NECESSARY. PLEASE FOLLOW THE INFORMATION PROVIDED BELOW TO FULLY ENJOY YOUR FURNITURE.

BASIC ASSEMBLY TECHNIQUES

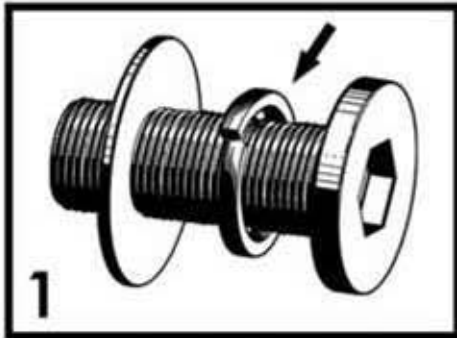

1 Before attaching each of the screws, make sure that the **smaller lock washer is between** the larger washer and the head of the screw.

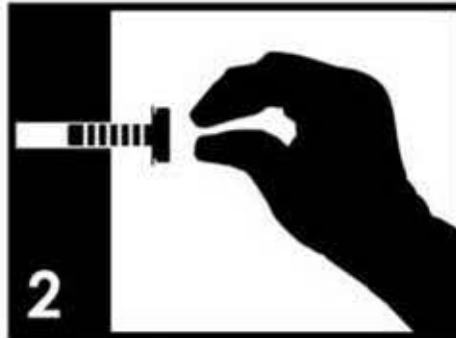

2 Position each part correctly and insert all screws into their respective holes. Then, **hand-tighten** only until 70% tight. Complete tightening with the tools will come at a later step.



3 Make sure the furniture rests on a **flat and level surface** with each leg evenly touching the ground. Use a soft blanket or carpet underneath when turning the piece on its side.

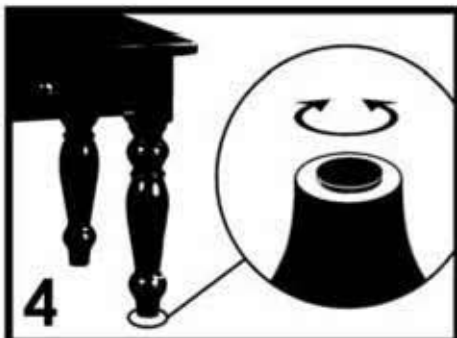

4 Some furniture come with optional **height adjustment knobs** underneath each leg. Turn this knob counterclockwise to raise the leg level or clockwise to lower the leg level.

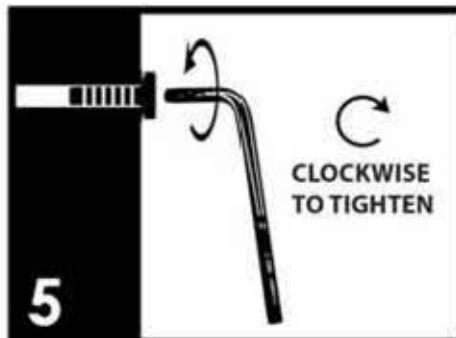

5 Finally, make sure all parts are properly aligned then use the included **tools** to completely tighten the screws. Your furniture is now ready for use.



6 Store the **tools** for later maintenance. Tighten the screws again **after two (2) weeks**, and then at least **once every six (6) months** after that.

IT IS THE USER'S RESPONSIBILITY TO MAINTAIN THE FURNITURE. THE SCREWS MAY LOOSEN OVER TIME AND CAUSE THE FURNITURE TO BE WOBBLY AND UNABLE TO SUPPORT ITS INTENDED WEIGHT CAPACITY. THIS CAN LEAD TO COLLAPSE AND CAN CAUSE SERIOUS INJURY.



FAILURE TO FOLLOW THE GUIDELINES ABOVE MAY RESULT IN INJURY AND/OR PROPERTY DAMAGE.

**** IMPORTANT ****

MUST READ BEFORE ASSEMBLY!

FOR YOUR FURNITURE TO LAST, CORRECT ASSEMBLY AND PROPER MAINTENANCE ARE NECESSARY. PLEASE FOLLOW THE INFORMATION PROVIDED BELOW TO FULLY ENJOY YOUR FURNITURE.

BASIC ASSEMBLY TECHNIQUES

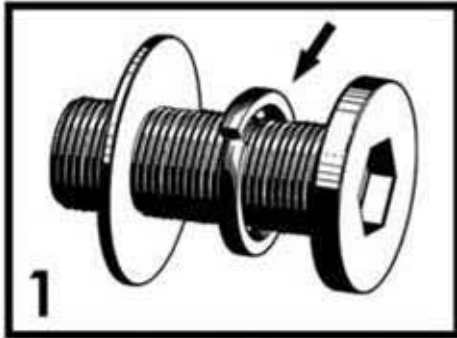

Before attaching each of the screws, make sure that the **smaller lock washer is between** the larger washer and the head of the screw.

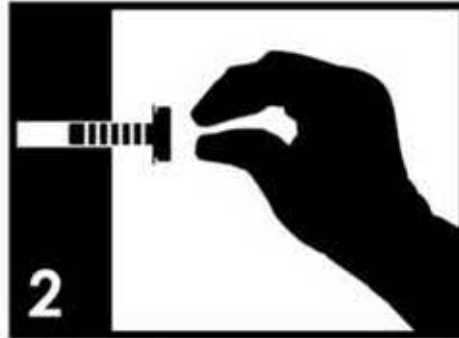

Position each part correctly and insert all screws into their respective holes. Then, **hand-tighten** only until 70% tight. Complete tightening with the tools will come at a later step.



Make sure the furniture rests on a **flat and level surface** with each leg evenly touching the ground. Use a soft blanket or carpet underneath when turning the piece on its side.

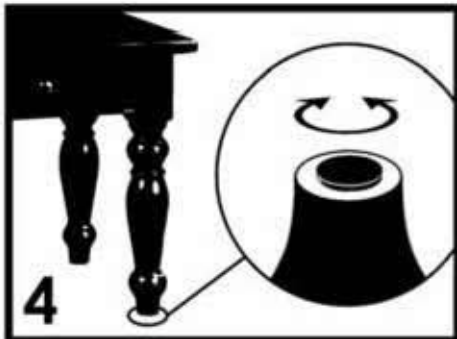

Some furniture come with optional **height adjustment knobs** underneath each leg. Turn this knob counterclockwise to raise the leg level or clockwise to lower the leg level.

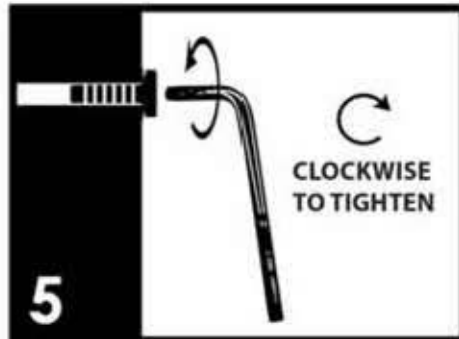

Finally, make sure all parts are properly aligned then use the included **tools** to completely tighten the screws. Your furniture is now ready for use.



Store the **tools** for later maintenance. Tighten the screws again **after two (2) weeks**, and then at least **once every six (6) months** after that.





IT IS THE USER'S RESPONSIBILITY TO MAINTAIN THE FURNITURE. THE SCREWS MAY LOOSEN OVER TIME AND CAUSE THE FURNITURE TO BE WOBBLY AND UNABLE TO SUPPORT ITS INTENDED WEIGHT CAPACITY. THIS CAN LEAD TO COLLAPSE AND CAN CAUSE SERIOUS INJURY.



FAILURE TO FOLLOW THE GUIDELINES ABOVE MAY RESULT IN INJURY AND/OR PROPERTY DAMAGE.

202-606GY

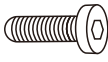
ASSEMBLY INSTRUCTIONS INSTRUCTION D'ASSEMBLAGE

A  1pc/unités	B  1pc/unités	C  4pcs/unités	D  4pcs/unités	E  1pc/unités
---	---	--	---	---

