

Miranda 403-405BL ASSEMBLY INSTRUCTIONS INSTRUCTION D'ASSEMBLAGE

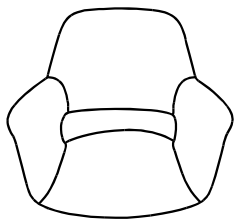

Ax1

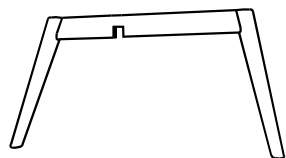

Bx1

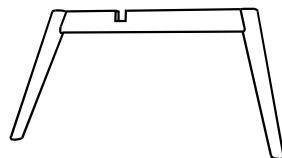

Cx1



Dx4



Ex1



Fx5



Gx1

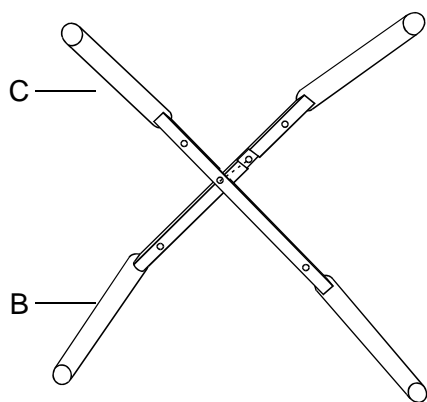

1

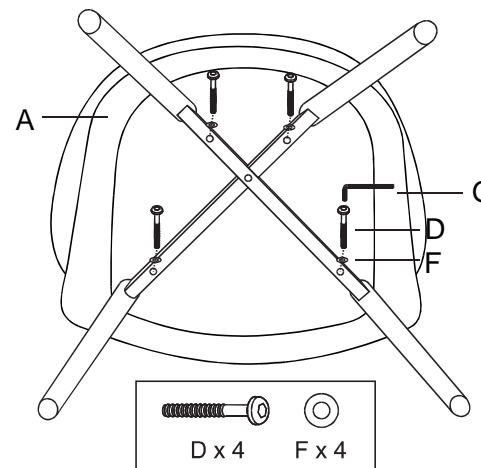

2

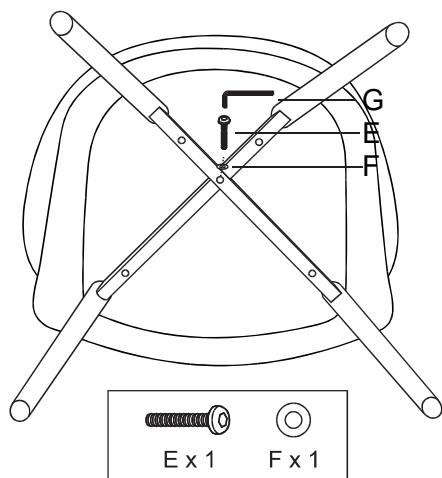

3

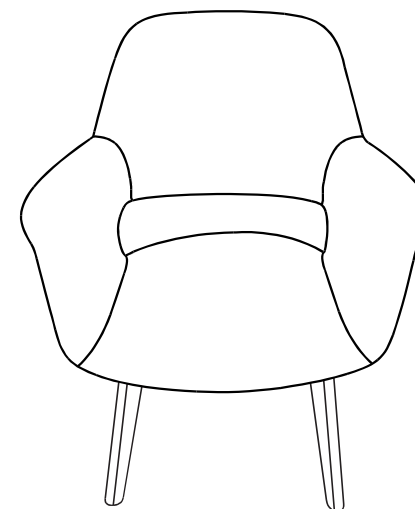

4