





# PETRIE ACCENT CHAIR 403-556

## ASSEMBLY INSTRUCTIONS

### INSTRUCTION D'ASSEMBLAGE

NO.	PARTS	Q'TY
A		1
B		1
C		4
D		1
E		1

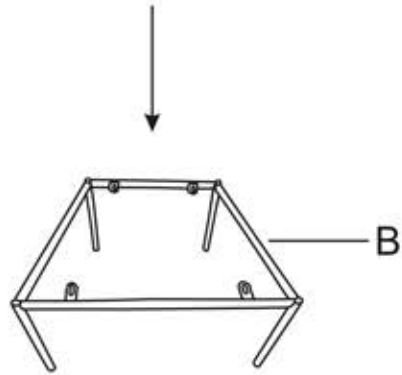
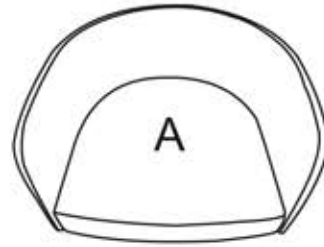

**STEP 1**

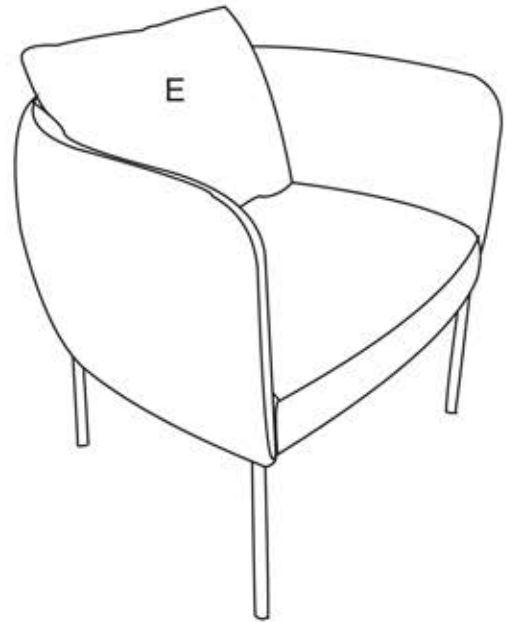
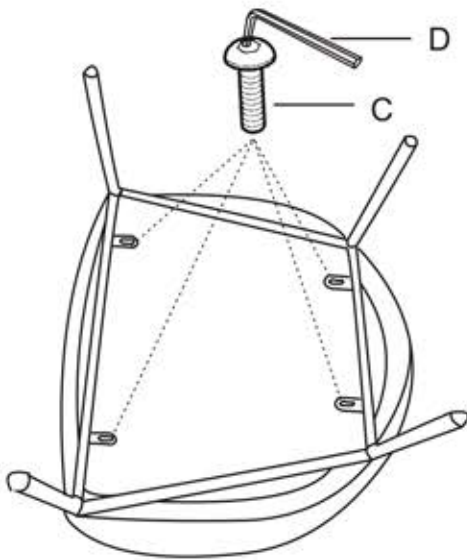

**STEP 2**

**STEP 3**